

Register your product and get support at
www.philips.com/welcome

POCKET MEMO

LFH9380/27



EN	User manual	3
DE	Benutzerhandbuch	29
FR	Manuel de l'utilisateur	55

ES	Manual del usuario	81
IT	Manuale di istruzioni	107
NL	Gebruikershandleiding	133

PHILIPS

User manual

1	Important	2	5	Use more of your Pocket Memo	19
			5.1	Use Philips SpeechExec software	19
			5.1.1	Advanced configuration	19
			5.1.2	Download recordings to the PC	19
2	Your Pocket Memo	3	5.2	Menu settings	20
2.1	Product highlights	3	5.2.1	Menu list	20
2.2	What's in the box	3	5.3	Use voice-activated recording	21
2.3	Overview	4	5.4	Work with index marks	22
2.3.1	Controls and connections	4	5.4.1	Insert an index mark	22
2.3.2	Display indicators and symbols	5	5.4.2	Delete an index mark	23
			5.4.3	Delete all index marks	23
3	Get started	6	5.5	Assign an author's name	24
3.1	Install the batteries	6	6	Technical data	25
3.2	Use rechargeable batteries	6			
3.3	Insert and eject the memory card	7			
3.4	Format a new memory card	7			
3.5	Activate the Pocket Memo	8			
3.5.1	Set the language	8			
3.5.2	Set the date and time	8			
3.6	Power-save mode	9			
4	Use your Pocket Memo	10			
4.1	Recording	10			
4.1.1	Create a recording	10			
4.1.2	Add to a recording (insert/overwrite)	11			
4.1.3	Finish (lock) a recording	12			
4.1.4	Change the recording format	13			
4.1.5	Adjust the microphone sensitivity	14			
4.2	Playback	15			
4.2.1	Overview of playback functions	16			
4.3	Delete	16			
4.3.1	Delete a file	16			
4.3.2	Delete part of a recording	17			
4.3.3	Delete all dictations	18			

1 Important

Philips reserves the right to change products at any time without being obliged to adjust earlier supplies accordingly.

The material in this manual is believed adequate for the intended use of the system. If the product, or its individual modules or procedures, are used for purposes other than those specified herein, confirmation of their validity and suitability must be obtained.

Safety

- To avoid a short circuit, do not expose the product to rain or water.
- Do not expose the device to excessive heat caused by heating equipment or direct sunlight.
- Protect the cables from being pinched, particularly at plugs and the point where they exit from the unit.
- Back up your files. Philips is not responsible for any loss of data.

Hearing safety

Observe the following guidelines when using your headphones:

- Listen at reasonable volumes for reasonable periods of time.
- Be careful not to adjust the volume higher as your hearing adapts.
- Do not turn up the volume so high that you can't hear what's around you.
- You should use caution or temporarily discontinue use in potentially hazardous situations.
- Do not use headphones while operating a motorized vehicle, cycling, or skateboarding, etc. It may create a traffic hazard and is illegal in many areas.

Important (for models supplied with headphones):

Philips guarantees compliance with the maximum sound power of its audio players as determined by relevant regulatory bodies, but only with the original model of provided headphones. If these headphones need replacement, we recommend that you contact your retailer to order a Philips model identical to that of the original.

Small children

Your device and its enhancements may contain small parts. Keep them out of the reach of small children.

Disposal of your old product

- Your product is designed and manufactured with high quality materials and components that can be recycled and re-used.
- When this crossed-out wheeled bin symbol is attached to a product, it indicates that the product is covered by the European Directive 2002/96/EC.
- Become informed about your local separate collection system for electrical and electronic products.
- Act according to your local rules and do not dispose of old products with normal household waste. The correct disposal of old products will help prevent potential negative consequences for the environment and human health.
- Batteries (including built-in rechargeable batteries) contain substances that may pollute the environment. All batteries should be disposed of at an official collection point.



2 Your Pocket Memo

Congratulations on your purchase and welcome to Philips!

To fully benefit from the service that Philips offers, visit our Website for support information such as user manuals, software downloads, warranty information and more: www.philips.com/support.

2.1 Product highlights

- The Pocket Memo's asymmetrical and ergonomic design delivers unparalleled user-friendly operation. All buttons are within the sweep-angle of the thumb.
- Two smart buttons let you scroll through menu options and quickly make selections.
- A large graphical display lets you view all file information, such as keywords (author name), length of dictation, position within the file, and other vital information at a glance. A backlit display shows all information, even in poor lighting conditions.
- The .dss file format is the international standard for professional speech processing. Offering excellent audio quality for recorded voice, .dss files allow a high compression rate, reduced file sizes, network traffic and required storage capacity.
- SpeechExec Dictate is the perfect download software to manage voice files. The intuitive user interface makes job retrieval simple and fast, and the job status information allows the tracking of all the work in progress.

2.2 What's in the box



Pocket Memo

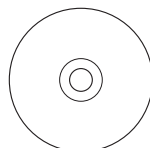

CD-ROM containing software and user manual



Memory card



Rechargeable batteries



Pouch



USB cable



Quick start guide

2.3 Overview

2.3.1 Controls and connections

- ① Microphone socket
- ② Headphone socket
- ③ Built-in microphone
- ④ Status LED
- ⑤ EOL (end-of-letter) button
- ⑥ Slide switch
- ⑦ On/off switch
- ⑧ Speaker
- ⑨ Display
- ⑩ Smart buttons
- ⑪ Menu button
- ⑫ +/-, menu navigation and volume control

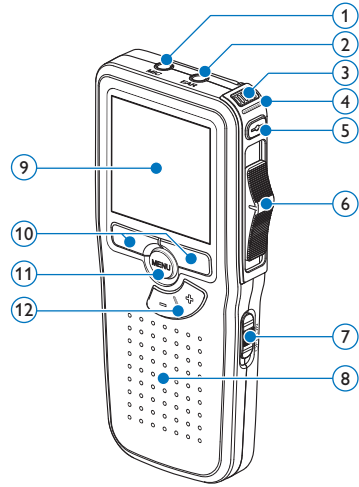

- ⑬ Memory card slot
- ⑭ FWD (forward) button
- ⑮ Battery compartment
- ⑯ Docking station connection slot
- ⑰ Power supply socket
- ⑱ USB connection slot

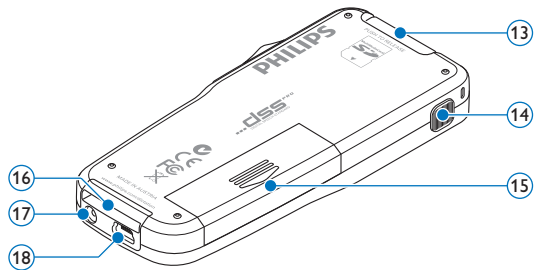

2.3.2 Display indicators and symbols

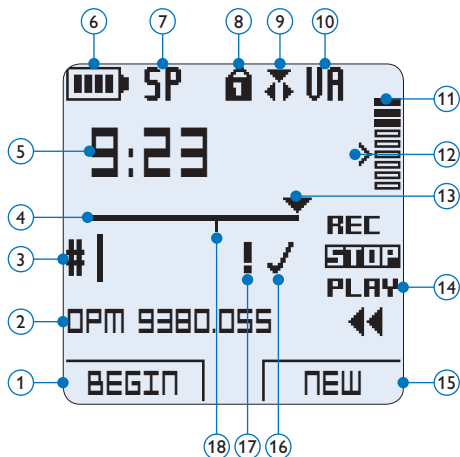

- | | |
|---|---|
| ① Current function of the left smart button | ⑪ Recording level meter |
| ② File name | ⑫ Sensitivity level for voice-activated recording |
| ③ Recording number | ⑬ Current position in the recording |
| ④ Position bar | ⑭ Positions of the slide switch |
| ⑤ Recording / playback time | ⑮ Current function of the right smart button |
| ⑥ Battery level indicator | ⑯ Recording is marked finished (EOL) and locked |
| ⑦ Recording format | ⑰ Recording is marked priority |
| ⑧ Memory card is write-protected (locked) | ⑱ Recording contains index mark |
| ⑨ Insert recording mode is activated | |
| ⑩ Voice-activated recording in progress | |

3 Get started

3.1 Install the batteries

The Pocket Memo can be operated with the two AAA rechargeable batteries LFH9154 delivered with the product. Standard (non-rechargeable) AAA alkaline batteries may also be used.

- 1 The on/off switch of the Pocket Memo must be in the **OFF** position.
- 2 Open the battery compartment on the back side of the Pocket Memo by sliding it outwards then folding it up.

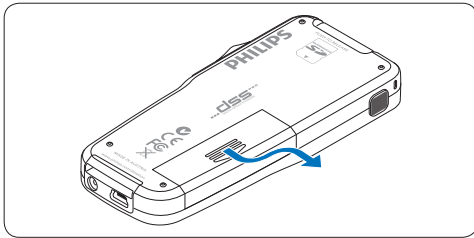

- 3 Insert the two AAA batteries. The correct polarity is indicated on the inside of the battery compartment cover.

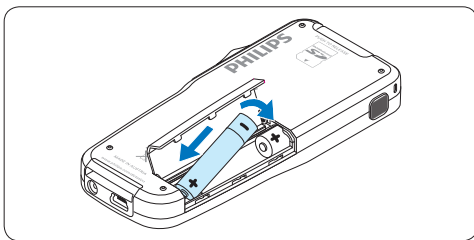
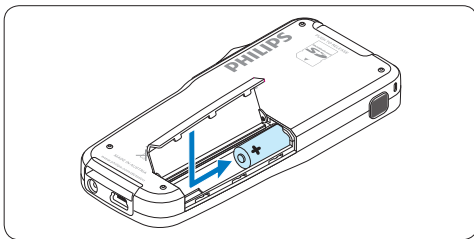

- 4 Close the battery compartment by folding it down and sliding the battery compartment cover inward until it clicks.

Note

Do not mix battery types! Use two rechargeable batteries (Philips LFH9154) or two non-rechargeable alkaline batteries.

3.2 Charge the batteries

The Pocket Memo can be operated with *Philips rechargeable batteries LFH9154*. To recharge these batteries, use USB cable. Optionally, the *Philips Power Supply 9146* or the *USB Docking Station 9120* may also be used.

When the Pocket Memo is connected to a PC or notebook computer with the supplied USB cable, the rechargeable batteries are automatically recharged. If the USB port on the computer is high powered, a complete recharge cycle takes about 2.5 hours.

Note

The PC must be ON when charging battery via the USB cable connection. The Pocket Memo may become warm during fast recharging.

Important

If the USB port of the computer does not supply enough power capacity (500 mA), disable the USB quick charge function in the menu of the Pocket Memo and recharge.

3.3 Insert and eject the memory card

The Pocket Memo operates with a SD (SecureDigital) memory card and supports SDHC cards with storage capacities of up to 32 GB.

To insert a memory card:

- 1 Locate the memory card slot on the top back side of the Pocket Memo.
- 2 Slide the memory card into the slot. A small illustration under the memory card slot indicates the correct orientation.
- 3 Push the memory card in until it clicks.

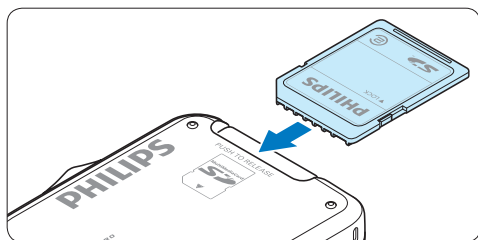

To eject the memory card:

- 1 Locate the memory card slot on the top back side of the Pocket Memo.
- 2 Press the memory card into the Pocket Memo until it clicks.
- 3 Release the memory card. It will slightly emerge from the memory card slot. Simply slide it out.

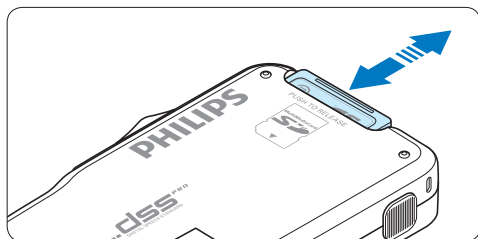

Note

If the Pocket Memo is turned to the **ON** position and there is no memory card inserted, a warning screen is displayed.

3.4 Format a new memory card

When a new, unformatted memory card (or a memory card that was formatted with a non-Pocket Memo device) is inserted, the Pocket Memo will display a prompt to format the memory card.

- 1 To confirm and start the formatting process, press the **OK** smart button.

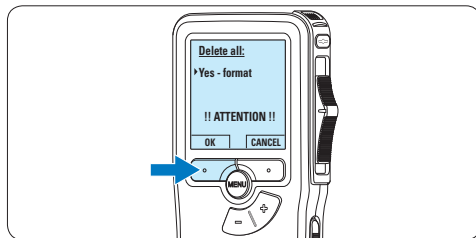

- 2 To cancel the formatting process, remove the memory card or press the **CANCEL** smart button.

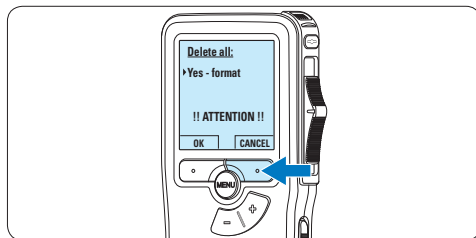

Note

Formatting is not possible if the memory card is in read-only mode (locked).

3.5 Activate the Pocket Memo

The Pocket Memo is turned on and off by sliding the **ON/OFF** switch. When using it for the first time, you will be prompted to set the language, date and time.

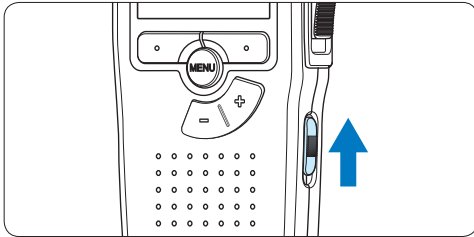

Note

It is possible to change the language later using the menu. See [5.2 Menu settings](#) on page 22 for more information.

3.5.2 Set the date and time

When using the Pocket Memo for the first time, you will be prompted to set the current date and time.

- 1 Press the **+** or **-** button to change the value for the year, month or day.

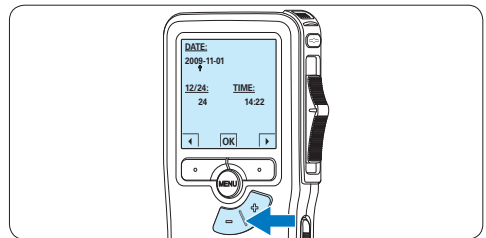

3.5.1 Set the language

When using the Pocket Memo for the first time, you will be prompted to set the language.

- 1 Press the **+** or **-** button on the Pocket Memo to select a language.

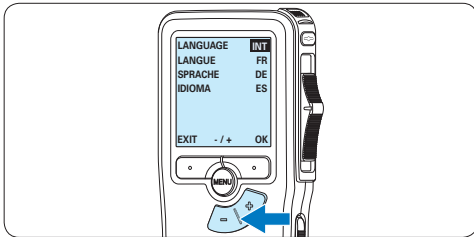

- 2 Press the **OK** smart button to confirm the selection. The selected language will be displayed.

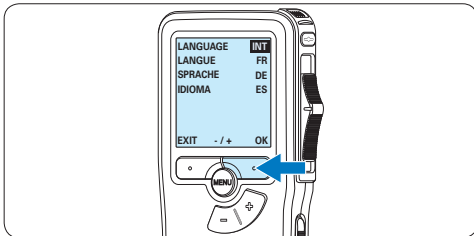

- 2 Press the **▶** smart button to advance the arrow (↑) to the next entry. After setting the day, press the **▶** smart button to advance the settings to the correct time.

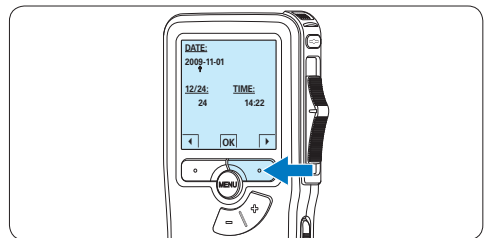

- 3 Press the **+** or **-** button to select a 12-hour or 24-hour clock, AM or PM (if a 12-hour clock is selected), and to change the value of the hour and minute settings.

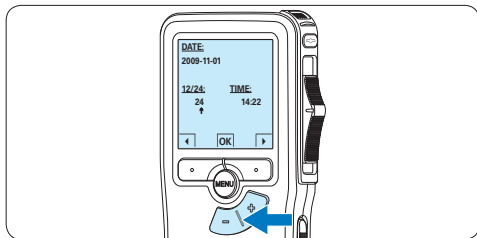

- 4 Press the  smart button to confirm the date and time.
The Pocket Memo is now ready to function.

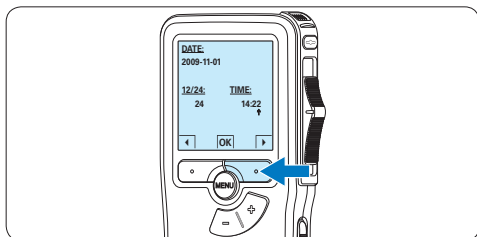

Note

If a mistake is made in setting the date/time, use the  smart button any time during the procedure to step back to make corrections. It is also possible to change the date and time later using the menu. See [5.2 Menu settings](#) on page 22 for more information.

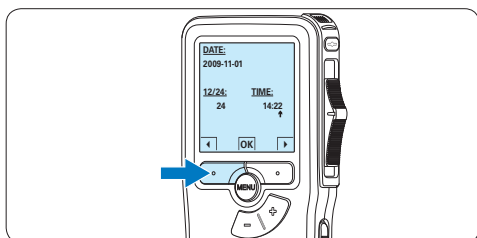

3.6 Power-save mode

After sixty minutes of inactivity, the Pocket Memo automatically goes into power-save mode and the LCD screen will display the date and time. Press any button to reactivate it. If the Pocket Memo is not used for more than two hours, it turns off completely. Turn the unit on by moving the On/Off switch to the **OFF** position and then back to the **ON** position.

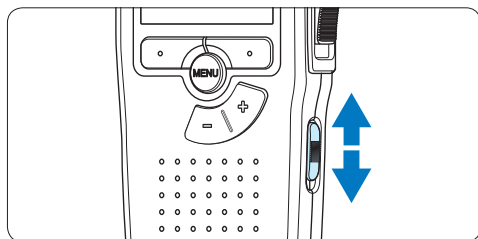

4 Use your Pocket Memo

4.1 Recording

4.1.1 Create a recording

Follow these steps to create a recording with the Pocket Memo:

- 1 A memory card must be inserted into the memory card slot. See [3.3 Insert and eject the memory card](#) on page 9 for more information.
- 2 Slide the On/Off switch to the **ON** position to switch on the Pocket Memo.

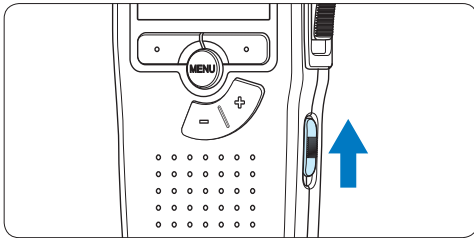

- 3 Press the **NEW** smart button to create a new recording.

Note

The **NEW** smart button is not displayed if the current recording is empty.

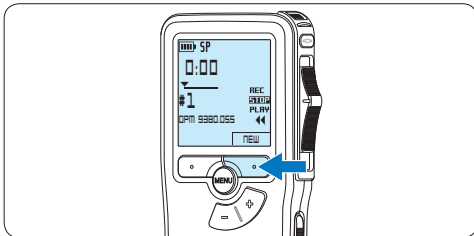

- 4 To start recording, move the slide switch to the **REC** position and start speaking.

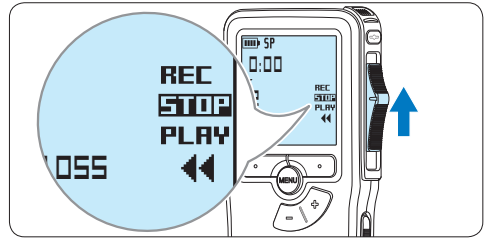

- The status LED glows in red (in overwrite mode) or green (in insert mode) while recording.
- The following information is displayed:
 - a Recording format
 - b Recording time
 - c Current position in the recording
 - d File number
 - e File name

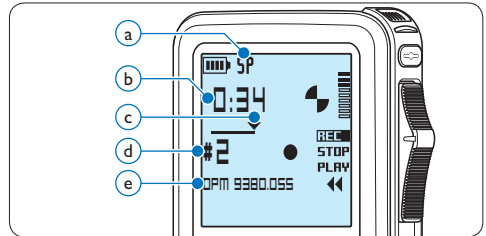

- 5 To stop recording, move the slide switch to the **STOP** position.

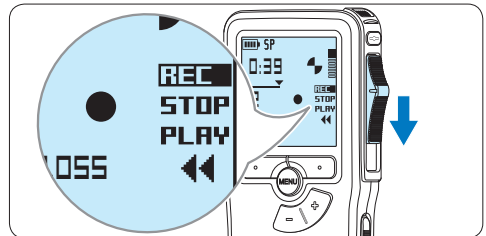

Note

For best results, speak clearly and keep the microphone about four inches (ten centimeters) away from your mouth.

4.1.2 Add to a recording (insert/overwrite)

Files are recorded in overwrite mode by default. Follow these steps to switch to insert mode to make additions to a recording:

- 1 Press the **MENU** button while in the stop position to open the menu.

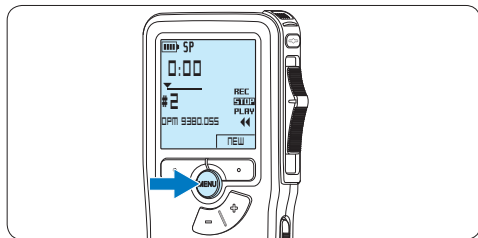

- 2 Press the **+** or **-** button to select the *Insert mode* menu and press the **ENTER** smart button to enter the submenu.

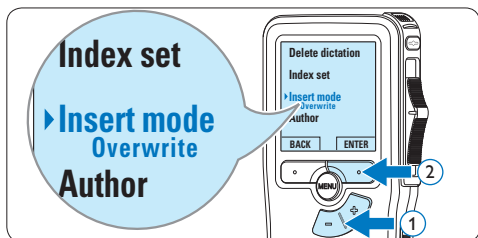

- 3 Press the **+** or **-** button to choose between *Insert* or *Overwrite* mode.
 - In *insert mode*, the record position of the slide switch reads **iREC** and the status LED glows in green while recording.
 - In *overwrite mode*, the record position of the slide switch reads **REC** and the status LED glows in red while recording.

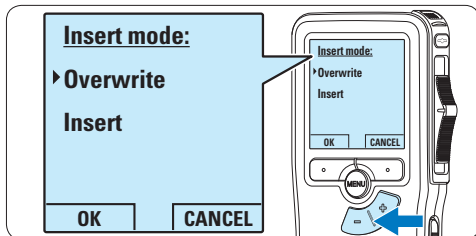

- 4 Press the **OK** smart button to save the setting or press the **CANCEL** smart button to exit the sub-menu without changing the setting.

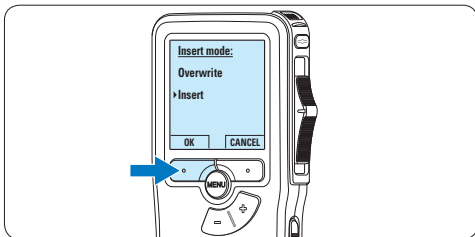

- 5 Press the **+** or **-** button to select the file into which the insertion should be made.

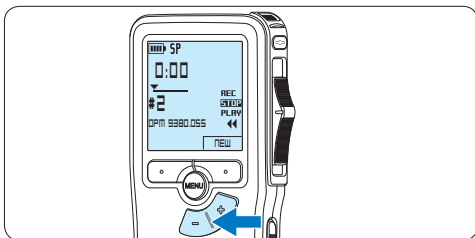

- 6 Play, forward or rewind to the position where the insertion should be made.
- 7 To insert an additional recording, move the slide switch to the **REC** position and start speaking. The insertion will not overwrite the recording.

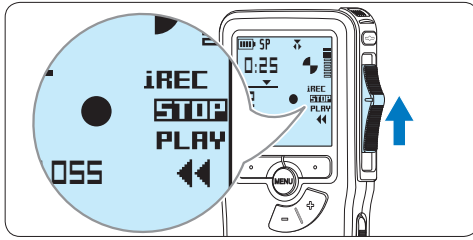

- 8** To end the inserted recording, move the slide switch to the **STOP** position.

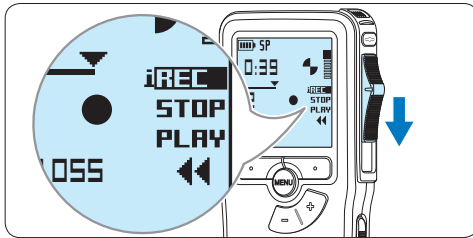

- 9** If the recording is not finished, simply fast forward to the end of the file and continue recording.
- 10** Repeat from step **1** to return to overwrite recording mode.

4.1.3 Finish (lock) a recording

When a recording is finished and no additional changes will be made, follow these steps to mark it as finished and protect it from being accidentally deleted:

- 1** Press the **+** or **-** button while in the stop position to select the recording to be marked finished.

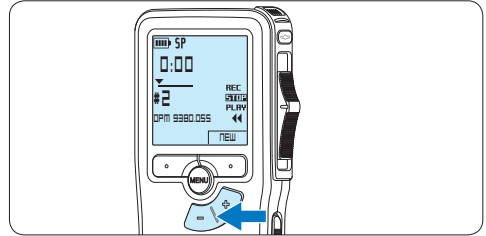

- 2** Press the end-of-letter (**EOL**) button to lock the file and mark it as finished.
The ✓ symbol is displayed.

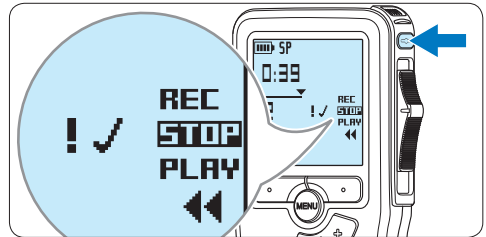

- 3** To assign priority status to the recording, press the **EOL** button again within half a second.
The ! symbol is displayed, indicating that the file has priority status.
- 4** To make changes to the recording, press the **EOL** button again to remove the finished mark.

* Tip

Philips SpeechExec software can be configured to download only those files from the Pocket Memo to the PC that are marked finished.

! Caution

Locked files are deleted when the memory card is formatted or the delete-all-dictations function is used.

4.1.4 Change the recording format

The recording format determines the audio quality of recordings and affects the number of audio files that can fit on the memory card. The Pocket Memo supports the following recording formats:

- Standard Play (SP) requires 1 megabyte for 10 minutes of recording.
- Quality Play (QP) requires 1 megabyte for 5 minutes of recording.

- 1** Press the **MENU** button while in the stop position to open the menu.

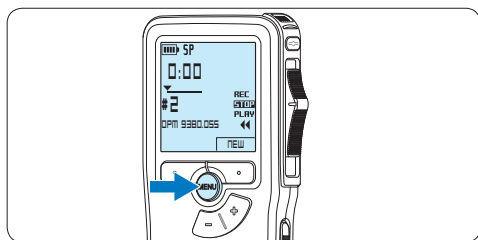

- 2** Press the **+** or **-** button to select the **Setup** menu item and press the **ENTER** smart button.

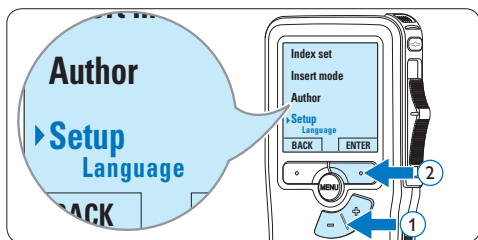

- 3** Press the **+** or **-** button to select the **Record format** menu item and press the **ENTER** smart button.

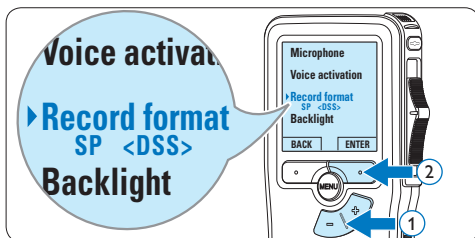

- 4** Press the **+** or **-** button to choose between **SP** and **QP**.

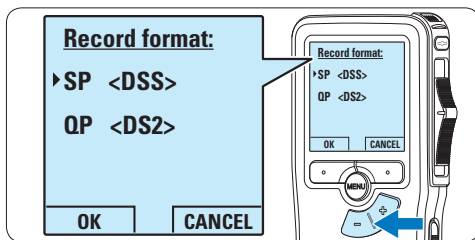

- 5** Press the **OK** smart button to save the setting or press the **CANCEL** smart button to exit the sub-menu without changing the setting.

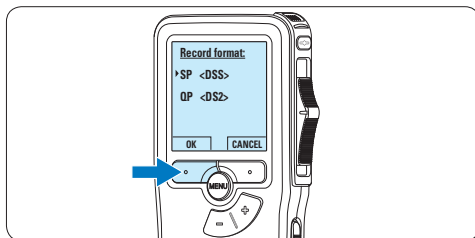

4.1.5 Adjust the microphone sensitivity

Set the microphone sensitivity for the environment and your recording preferences.

- 1 Press the **MENU** button while in the stop position to open the menu.

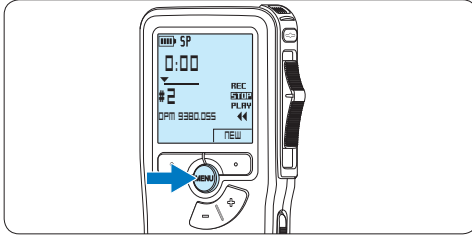

- 2 Press the **+** or **-** button to select the **Setup** menu item and press the **ENTER** smart button.

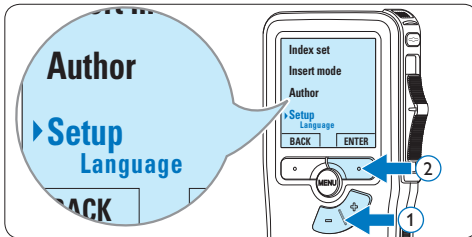

- 3 Press the **+** or **-** button to select the **Microphone** menu item and press the **ENTER** smart button.

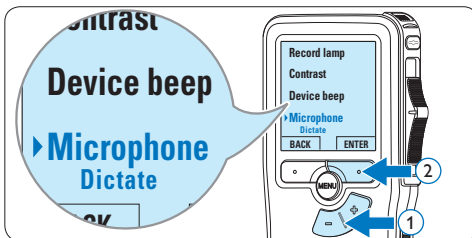

- 4 Press the **+** or **-** button to choose the microphone sensitivity: **Private** (low), **Dictate** (medium) and **Conference** (high).

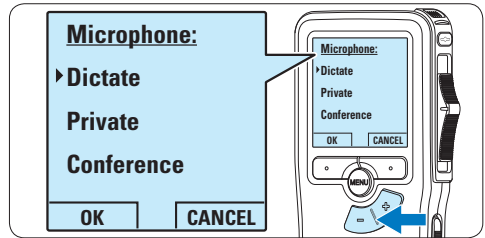

- 5 Press the **OK** smart button to save the setting or press the **CANCEL** smart button to exit the sub-menu without changing the setting.

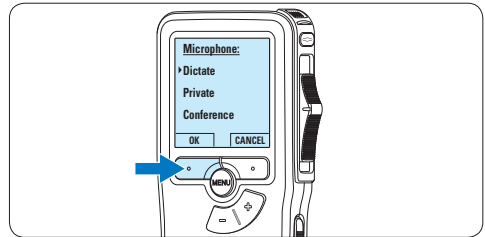

4.2 Playback

- 1 Press the **+** or **-** button while in the stop position to select the file to play and locate the beginning of the recording.

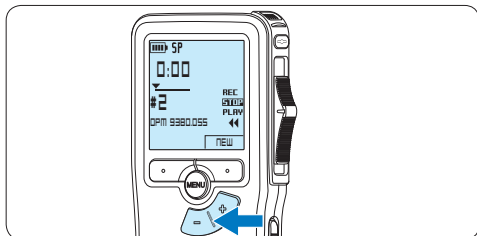

- 2 Move the slide switch to the **PLAY** position to start playback.

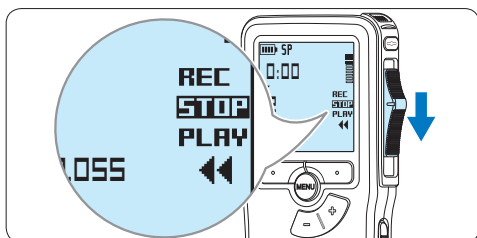

The following information is displayed:

- a Recording format
- b Playback position (minutes : seconds)
- c Current position in the recording
- d File number
- e File name

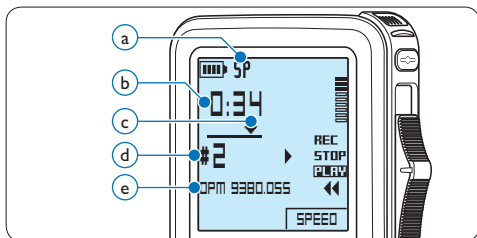

- 3 Press the **+** or **-** button to adjust the playback volume during playback.

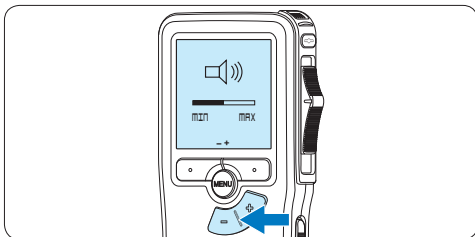

- 4 Press the **SPEED** smart button to adjust faster or slower file playback.

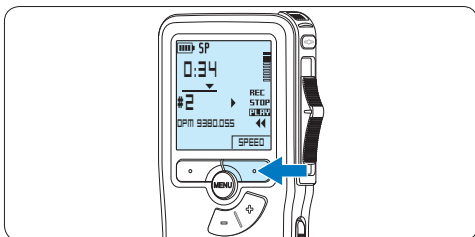

- 5 Move the slide switch to the **STOP** position to stop playback.

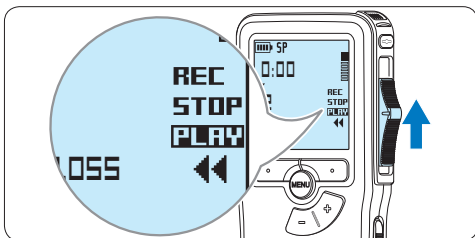

4.2.1 Overview of playback functions

File selection	Press the + button once while in the stop position to skip to the end of a file. Press the + button again to skip to the beginning of the next file. Press the - button once while in the stop position to skip to the beginning of a file. Press the - button again to skip to the end of the previous file.
Fast rewind	Move the slide switch to the ⏮ position. Move the slide switch to the STOP position to stop rewinding or the PLAY position to stop rewinding and begin playback.
Fast forward	Press and hold the FWD button while in the stop or play position. Release the FWD button to stop forwarding.
Playback speed	Press the SPEED smart button during playback to adjust faster or slower file playback.

4.3 Delete

ⓘ Note

Before deleting a file, make sure that it is not marked finished and that the memory card is not set to read-only (locked). If the file is marked finished, unlock it by pressing the **EOL** button once.

4.3.1 Delete a file

Follow these steps to delete a file entirely:

- 1 Press the **+** or **-** button while in the stop position to select the file to be deleted.

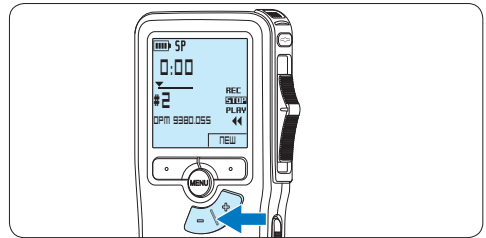

- 2 Press the **MENU** button to open the menu. The *Delete dictation* menu item is selected.

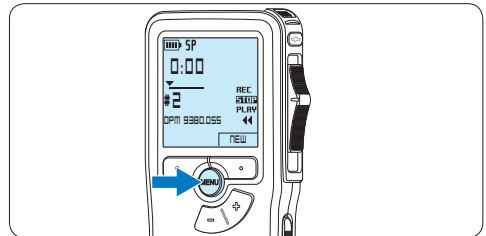

- 3 Press the **ENTER** smart button to enter the sub menu.

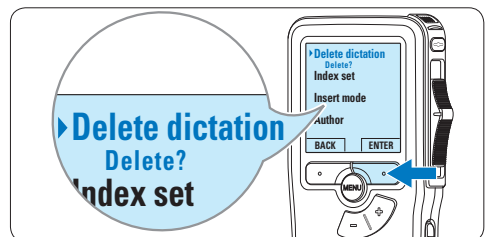

- 4 Press the **OK** smart button to delete the file permanently. Press the **CANCEL** smart button to cancel the operation and leave the recording intact.

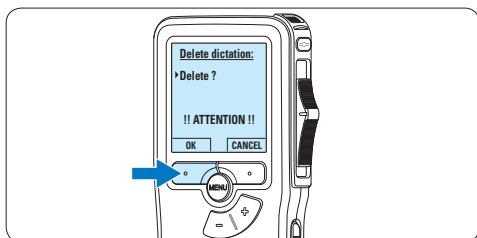

- 3 Using the play, forward or rewind functions, navigate to the beginning of the section to be deleted. Press the **MARK 1** smart button. A cross symbol appears on the screen.

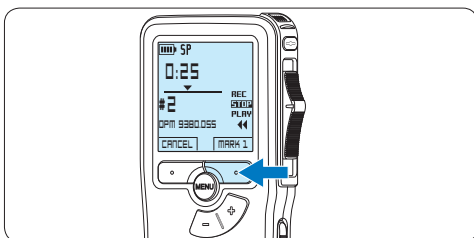

4.3.2 Delete part of a recording

Follow these steps to delete a section from a recording:

- 1 Press the **MENU** button while in the stop position to open the menu.

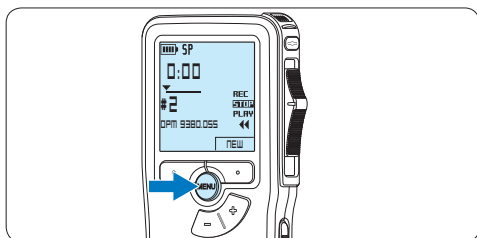

- 2 Press the **+** or **-** button to select the **Delete section** menu item and press the **OK** smart button.

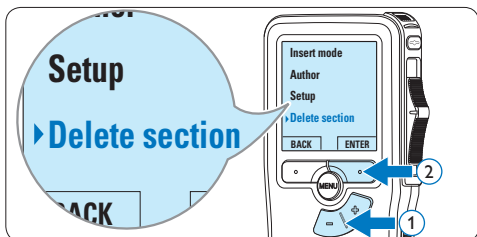

- 4 Navigate to the second mark position using playback, forward or rewind. Press the **MARK 2** smart button. The second cross appears.

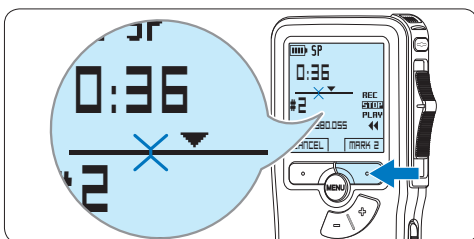

- 5 Press the **DELETE** smart button and the **OK** smart button to confirm the deletion of the marked section, or press the **CANCEL** smart button to exit without deleting.

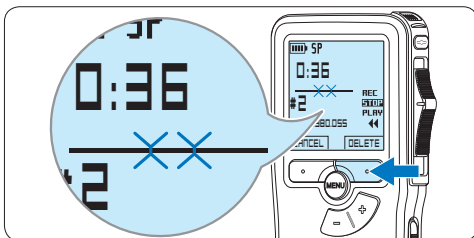

4.3.3 Delete all dictations

! Caution

Files marked finished (EOL) are deleted when the delete-all-dictations function is used.

Follow these steps to delete all recordings:

- 1 Press the **MENU** button while in the stop position to open the menu.

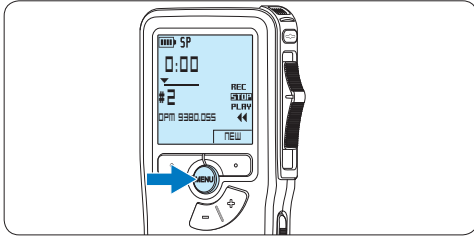

- 4 Press the **ENTER** smart button and the **OK** smart button to confirm the deletion, or press the **CANCEL** smart button to exit without deleting.

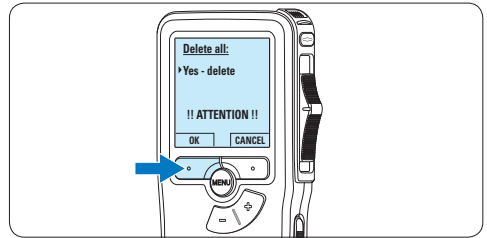

- 2 Press the **+** or **-** button to select the *Setup* menu item and press the **ENTER** smart button.

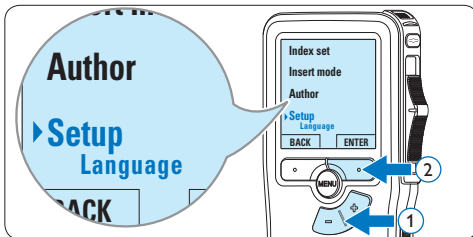

- 3 Press the **+** or **-** button to select the *Delete dictations* menu item and press the **ENTER** smart button.

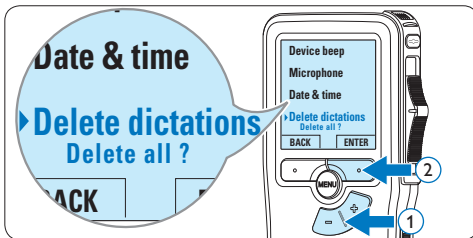

5 Use more of your Pocket Memo

5.1 Use Philips SpeechExec software

Philips SpeechExec software can be used for advanced configuration of the Pocket Memo and automatic download, conversion and routing of dictation files.

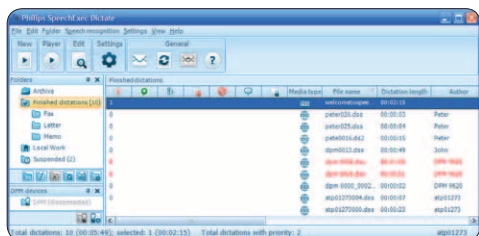

Note

For detailed information about *SpeechExec* software, refer to the *SpeechExec* user manual.

5.1.1 Advanced configuration

The Pocket Memo Configuration Wizard is part of the *Philips SpeechExec Dictate* software and guides users through the device configurations and settings of their Pocket Memo. The wizard assists users in configuring the time format, sound feedback, voice-activated recording, display appearance (standard or advanced display mode), the recording format, microphone sensitivity, author names, and file download to the PC.

- 1 Connect the Pocket Memo to the PC using a USB cable.
- 2 Start *Philips SpeechExec Dictate* software.
- 3 Click **Settings > General Settings** on the menu bar of *SpeechExec* to open the settings menu and select **DPM/DT Configuration > DPM Wizard** from the list on the left side.
- 4 Click the **Start Wizard...** button to open the

wizard. Follow the on-screen instructions to customize the Pocket Memo.

- 5 Click the **Finish** button to close the wizard and confirm the transfer of the new settings to the Pocket Memo.

Note

When the Pocket Memo is connected to the PC for the first time, Windows detects the new hardware and automatically installs the required drivers. When the installation is complete, Windows may prompt you to restart the PC.

5.1.2 Download recordings to the PC

With USB mass storage support, the Pocket Memo is automatically displayed as an external drive when it is connected to the computer. It can then be accessed easily with any Microsoft Windows program as a regular drive.

Use *Philips SpeechExec* software for automatic download, conversion and routing of files.

- 1 Make a recording with the Pocket Memo.
- 2 Start *Philips SpeechExec Dictate* software.
- 3 Connect the Pocket Memo to the PC using the USB cable or the optional USB docking station.
- 4 By default, the recordings on the Pocket Memo will be downloaded automatically to the PC and moved to the *Finished dictations* folder of the worklist.

Note

How and which files are downloaded after a Pocket Memo is connected can be configured in the settings menu of *SpeechExec* or with the Configuration Wizard.

5.2 Menu settings

To access the Pocket Memo menu:

- 1 Press the **MENU** button while stopped to open the Pocket Memo menu.

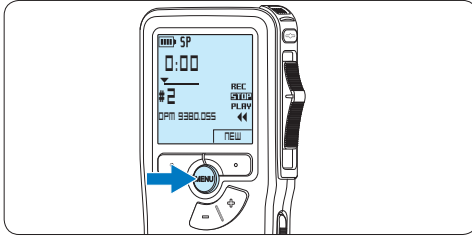

- 2 Press the **+** or **-** button to select the next/previous menu item.

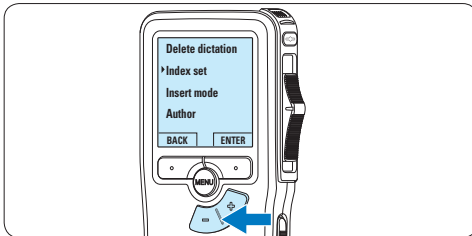

- 3 Press the **ENTER** smart button or the **MENU** button to enter a submenu.

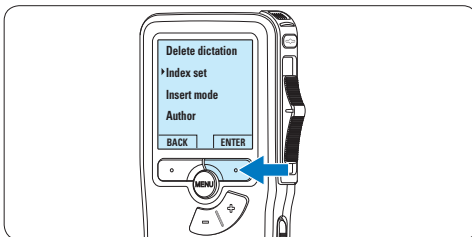

- 4 Press the **BACK** smart button to exit the menu.

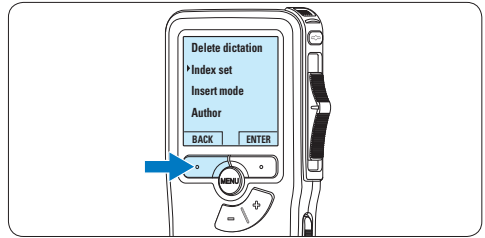

- 5 Press the **+** or **-** button to select a function.
- 6 Press the **OK** smart button to confirm a selection or the **CANCEL** smart button to exit a sub-menu without changing a setting.

5.2.1 Menu list

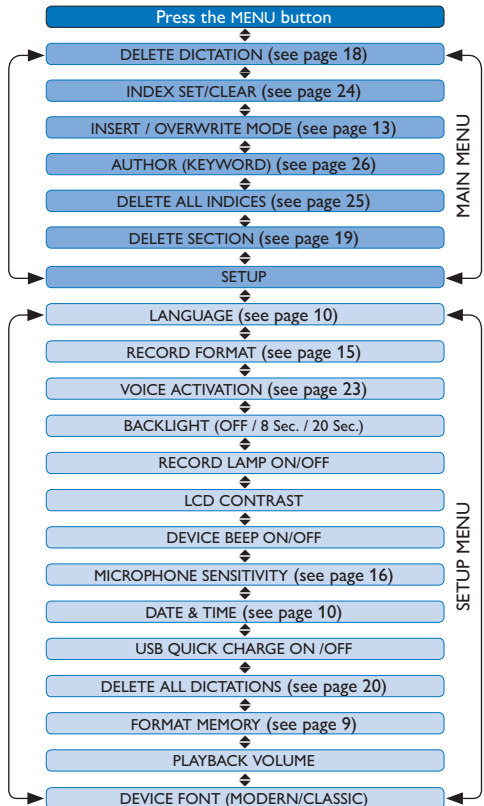

Note

- Some settings, such as defining author names or switching to the simple display mode, are available only through *Philips SpeechExec Dictate*. See [5.1.1 Advanced configuration](#) on page 21 for more information.
- Press and hold the **MENU** button for a few seconds to access additional information about files, the device, and the memory card.

5.3 Use voice-activated recording

Voice-activated recording is a convenience feature for hands-free recording. When voice-activated recording is enabled, recording will start when you begin speaking. When you stop speaking, the Pocket Memo will automatically pause recording after three seconds of silence, and resume only when you begin speaking again.

- 1 Press the **MENU** button while in the stop position to open the menu.

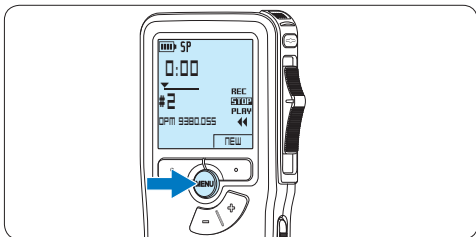

- 2 Press the **+** or **-** button to select the *Setup* menu item and press the **ENTER** smart button.

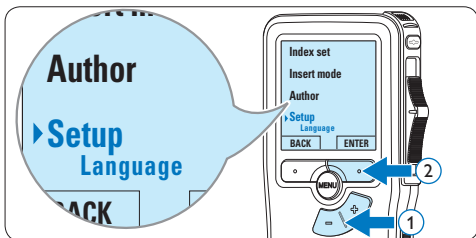

- 3 Press the **+** or **-** button to select the *Voice activation* menu item and press the **ENTER** smart button.

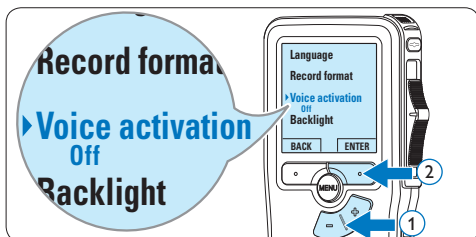

- 4 Press the **+** or **-** button to choose *Off* or *On*.

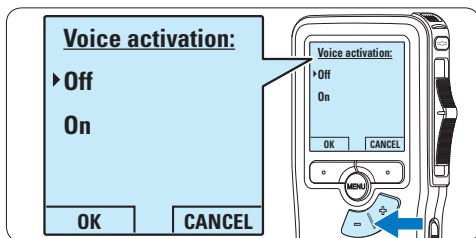

- 5 Press the **OK** smart button to save the setting or press the **CANCEL** smart button to exit the sub-menu without changing the setting.

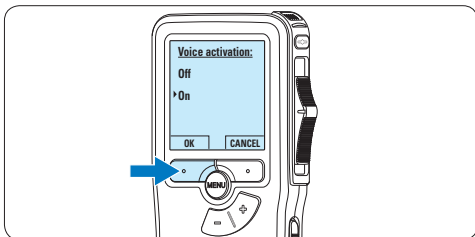

- 6 To start recording, move the slide switch to the **REC** position and start speaking. The status LED glows in red (in overwrite mode) or green (in insert mode) while recording. When the sound level drops below the threshold sound level, recording pauses after three seconds and the status LED flashes.

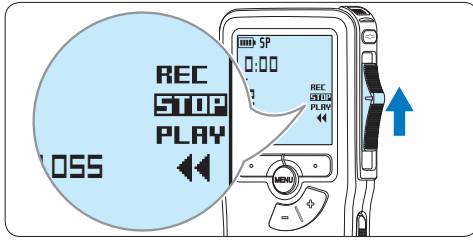

- 7 Press the **+** or **-** button to adjust the threshold sound level while recording.

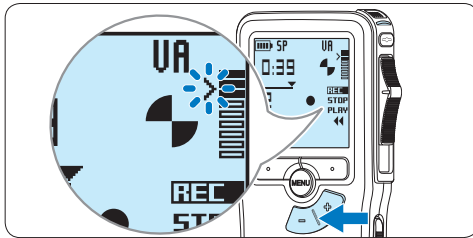

- 8 To stop recording, move the slide switch to the **STOP** position.

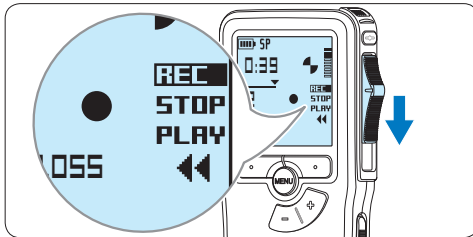

5.4 Work with index marks

Index marks can be used to mark certain points in a recording as points of reference. A point of reference may be the beginning of a major section, or a part of the recording that you may want to revise later or access quickly.

5.4.1 Insert an index mark

- 1 Play back, fast forward or fast rewind to the position where the index mark should be set.
- 2 Press the **MENU** button while in the stop position to open the menu.

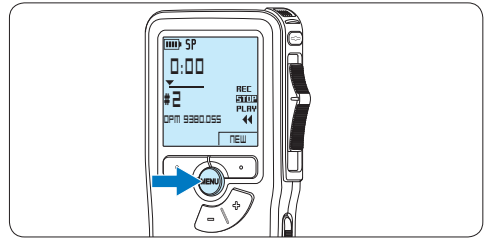

- 3 Press the **+** or **-** button to select the *Index set* menu and press the **OK** smart button.

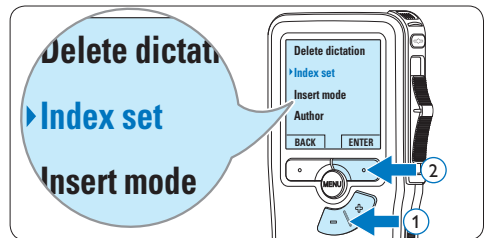

5.4.2 Delete an index mark

- 1 Play back, fast forward or fast rewind to the index mark to be deleted.
- 2 Press the **MENU** button while in the stop position to open the menu.

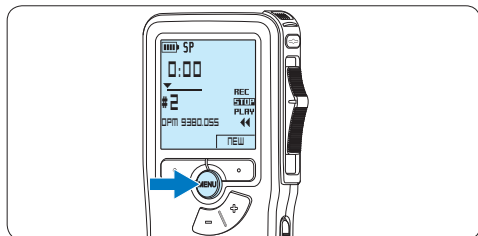

- 3 Press the **+** or **-** button to select the *Index clear* menu and press the **OK** smart button.

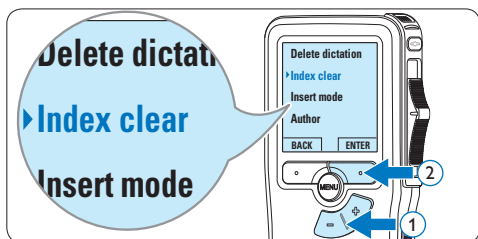

5.4.3 Delete all index marks

- 1 Press the **MENU** button while in the stop position to open the menu.

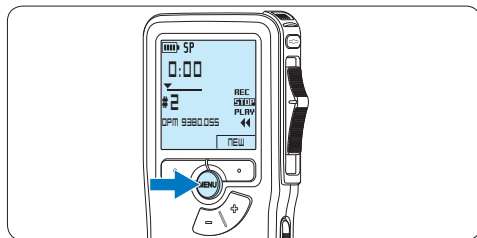

- 2 Press the **+** or **-** button to select the *Delete indices* menu item and press the **ENTER** smart button.

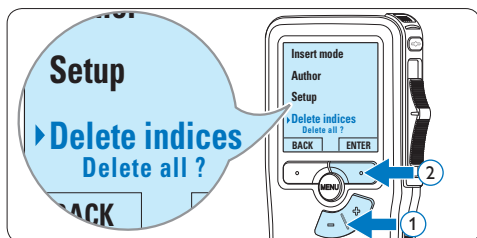

- 3 Press the **ENTER** smart button and the **OK** smart button to confirm the deletion, or press the **CANCEL** smart button to exit without deleting.

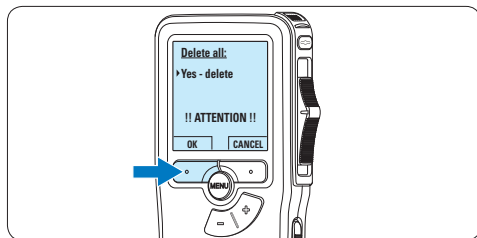

Note

The *Delete Indices* menu item is available only if the current file has at least one index mark.

5.5 Assign an author's name

A keyword, such as the author's name can be assigned to every recording. The keyword can be used to identify recordings and automatic file routing in *Philips SpeechExec* software.

Note

Author names must first be set up with *Philips SpeechExec* software. See [5.1.1 Advanced configuration](#) on page 21 for more information. By default, the keyword category **AUTHOR** with the keywords 'DPM 9380' and '- - -' (empty = default) is available on the Pocket Memo.

To assign an author's name to a recording:

- 1 Press the **MENU** button while in the stop position to open the menu.

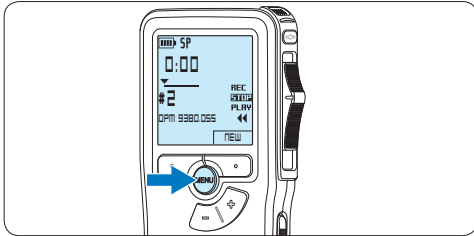

- 2 Press the **+** or **-** button to select the **Author** menu item.

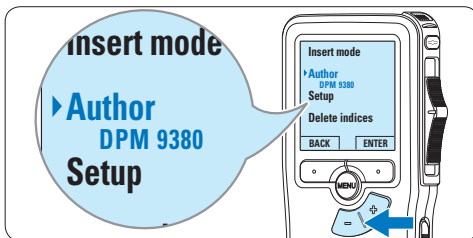

- 3 Press the **ENTER** smart button to display the list of names.

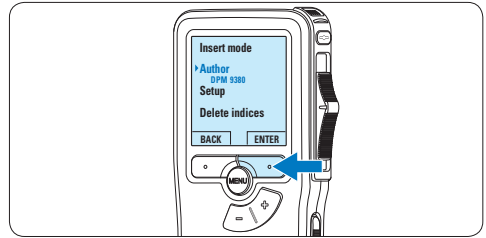

- 4 Press the **+** or **-** button to select a name.

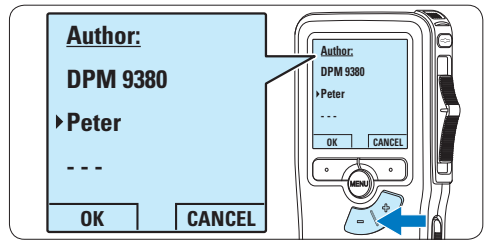

- 5 Press the **OK** smart button to confirm or the **CANCEL** smart button to exit without assigning a name.

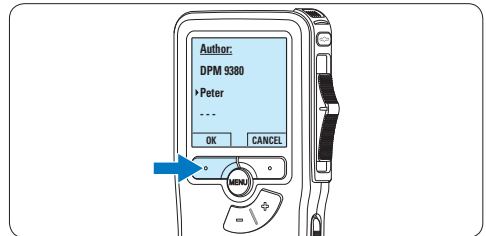

6 Technical data

Connectivity

- Headphones: 3.5 mm
 - Microphone: 3.5 mm
 - USB: High-speed USB 2.0
 - Docking connector
 - Memory card slot
-

Display

- Type: LCD
 - Diagonal screen size: 44 mm/1.7 in.
 - Backlight: white
-

Storage media

- Exchangeable memory card
 - Memory card types: Secure Digital (SD), Secure Digital (SDHC)
 - Mass storage class compliant
-

Audio recording

- Recording formats: Digital speech standard (DSS)
 - Built-in microphone: mono
 - Recording modes: QP (DSS/mono), SP (DSS/mono)
 - Bit rate: 13.5, 27 kbps
 - Recording time (2 GB card): 349 hours (SP), 170 hours (QP)
 - Sample rate: 16 kHz (QP), 12 kHz (SP)
-

Sound

- Speaker type: built-in round dynamic speaker
 - Speaker diameter: 30 mm
 - Speaker output power: 200 mW
 - Frequency response: 300–7,000 Hz (QP), 300–5,700 Hz (SP) Hz
-

Convenience

- Professional editing functions
 - Multiple language support: 4 languages (EN, FR, DE, ES)
 - 2 smart buttons
 - Author ID setting
 - Control via slide switch
-

- File lock
 - One-thumb operation
 - Priority setting
 - Voice-activated recording
 - Automatic software updates
-

Power

- Battery type: AAA/LR03 Alkaline, Philips AAA Ni-MH LFH9154
 - Number of batteries: 2
 - Rechargeable: yes, via USB
 - Battery lifetime: up to 23 hours in SP recording mode
 - Batteries included
-

System requirements

- Processor: Pentium III 1GHz, Pentium IV recommended
 - RAM memory: 512 MB (1 GB recommended)
 - Hard disk space: 100 MB for SpeechExec, 250MB for Microsoft .NET
 - Headphone output or speakers
 - Operating system: Windows 7/Vista/XP
 - Free USB port
 - DVD-ROM drive
 - Sound card
-

Green specifications

- Compliant to 2002/95/EC (RoHS)
 - Lead-free soldered product
-

Accessories

- SpeechExec Dictate software
 - USB cable
 - Secure Digital memory card
 - Pouch
 - Quick start guide
 - 2 × AAA batteries
-

Design and finishing

- Color(s): silver/black
 - Material: full metal body
-

Federal Communications Commission Notice

This equipment has been tested and found to comply with the limits for a Class B digital device, pursuant to part 15 of the FCC Rules. These limits are designed to provide reasonable protection against harmful interference in a residential installation. This equipment generates, uses, and can radiate radio frequency energy and, if not installed and used in accordance with the instructions, may cause harmful interference to radio communications. However, there is no guarantee that interference will not occur in a particular installation. If this equipment does cause harmful interference to radio or television reception, which can be determined by turning the equipment off and on, the user is encouraged to try to correct the interference by one or more of the following measures:

- Reorient or relocate the receiving antenna.
- Increase the separation between the equipment and the receiver.
- Connect the equipment into an outlet on a circuit different from that to which the receiver is connected.
- Consult the dealer or an experienced radio or television technician for help.

Modifications

The FCC requires the user to be notified that any changes or modifications made to this device that are not expressly approved by Philips may void the user's authority to operate the equipment.

Cables

Connections to this device must be made with shielded cables with metallic RFI/EMI connector hoods to maintain compliance with FCC Rules and Regulations.

Canadian notice

This Class B digital apparatus meets all requirements of the Canadian Interference-Causing Equipment Regulations.

Avis Canadien

Cet appareil numérique de la classe B respecte toutes les exigences du Règlement sur le matériel brouilleur du Canada.

Declaration of Conformity

Model Number: LFH9380
Trade Name: Philips Pocket Memo
Responsible Party: Philips Speech Processing
Address: 64 Perimeter Center East,
Atlanta, GA 30346, USA
Telephone number: 888-260-6261
Website: www.philips.com/dictation

LFH9380



Tested to comply with
FCC standards

FOR HOME OR OFFICE USE

This device complies with Part 15 of the FCC Rules. Operation is subject to the following two conditions: 1) This device may not cause harmful interference. 2) This device must accept any interference received, including interference that may cause undesired operation.

CE Declaration of Conformity

Philips confirms that the product corresponds to the relevant guidelines of the European Union.



Specifications are subject to change without notice.

Trademarks are the property of Royal Philips Electronics or their respective owners.

© 2010 Royal Philips Electronics. All rights reserved.

Document Version 3.0, 16/12/2010.